

Main-Memory Databases

Motivation

Hardware trends

- Huge main memory capacity with complex access characteristics (Caches, NUMA)
- Many-core CPUs
- SIMD support in CPUs
- New CPU features (HTM)
- Also: Graphic cards, FPGAs, low latency networking,...

Database system trends

- Entire database fits into main memory
- New types of database systems
- New algorithms, new data structures

*“The End of an Architectural Era.
(It’s Time for a Complete Rewrite).”*

Recap: Database Workloads

Analytics

- Long-running
- Access large parts of the database
- Often use scans
- Read-only
- Example: “Average order value per year and product group?”

Transaction processing

- Short running
- (Multiple) point queries + simple control flow
- Insert/Update/Delete/Read data
- Example: “Increment account x by 10, decrement account y by 10”

Universal DBMS used for both (but not concurrently).

OLTP

Universal DBMS were optimized for 1970's hardware

- Small fraction of DB in memory buffer
- Hide and avoid disk access at any cost

Today

- Even enterprises can store entire DB in memory
- Transaction are often “one-shot”
- Transactions execute in a few *ms* or even μs

OLTP (2)

Main sources of overhead

- ARIES-style logging
- Locking (2PL)
- Latching
- Buffer Management

Useful work can be as low as $\frac{1}{60}$ th of instructions¹.

Modern systems avoid this overhead (see slide 9).

¹Harizopoulos et al. – *OLTP Through the Looking Glass, and What We Found There*

Physical Data Layout in Main Memory

Lightweight:

- Buffer Manager removed
- No need for segments
- No need for slotted pages

Store data in simple arrays. But: Row-wise or column-wise?

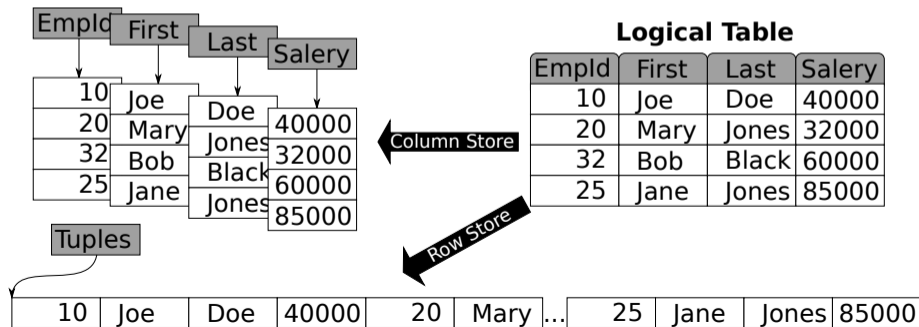

Physical Data Layout in Main Memory (2)

Row Store:

- Beneficial when accessing many attributes
- For OLTP

Column Store:

- Excellent cache utilization
- Sometimes individually sorted
- Compression potential
- Vectorized processing
- For OLAP

Hybrid Row/Column Stores possible

New Systems (Examples)

OLTP-only:

- VoltDB/H-Store
- Microsoft Hekaton

OLAP-only:

- Vectorwise
- MonetDB
- DB2 BLU

Hybrid OLTP *and* OLAP:

- SAP HANA
- HyPer

New Systems: OLTP (Examples)

Challenge:

- Avoid overhead
- Guarantee ACID

Approaches:

- Buffer Management: Removed
- Logging
 - ▶ H-Store/VoltDB: Log shipping to other nodes
 - ▶ Hekaton: Lightweight logging (no index structures)
- Locking:
 - ▶ H-Store/VoltDB: Serial execution (on private partitions)
 - ▶ Hekaton: Optimistic MVCC
- Latching
 - ▶ H-Store/VoltDB: Not necessary
 - ▶ Hekaton: Latch-free data structures

New Systems: Hekaton

- Integrated in SQL Server
- Code Generation
- Only access path: Index (Hash or B(w)-Tree)
- Latch-Free Indexes
- MVCC

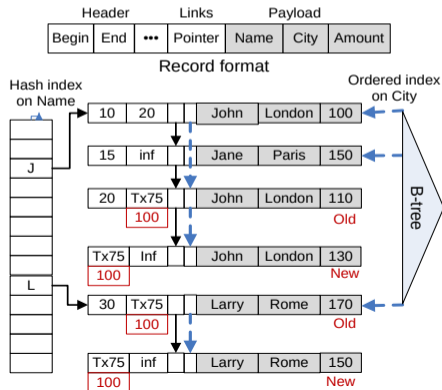

New Systems: OLAP

- Vectorwise: Vectorized Processing
- HyPer: Query Compilation (cf. Chapter *Code Generation*)

New Systems: Hybrid OLTP and OLAP

Traditionally:

- Mixing OLTP and OLAP leads to performance decline
- ETL architecture
- 2 systems, stale data

New Systems

- SAP HANA
 - ▶ Split DB into read-optimized *main* and update-friendly *delta*
 - ▶ OLAP queries read main, OLTP transactions read delta *and* main
 - ▶ Periodically merge main and delta
- HyPer: Virtual memory snapshots

HyPer: Virtual Memory Snapshots

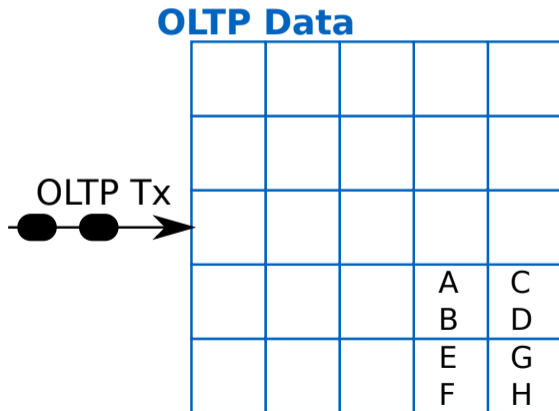

HyPer: Virtual Memory Snapshots

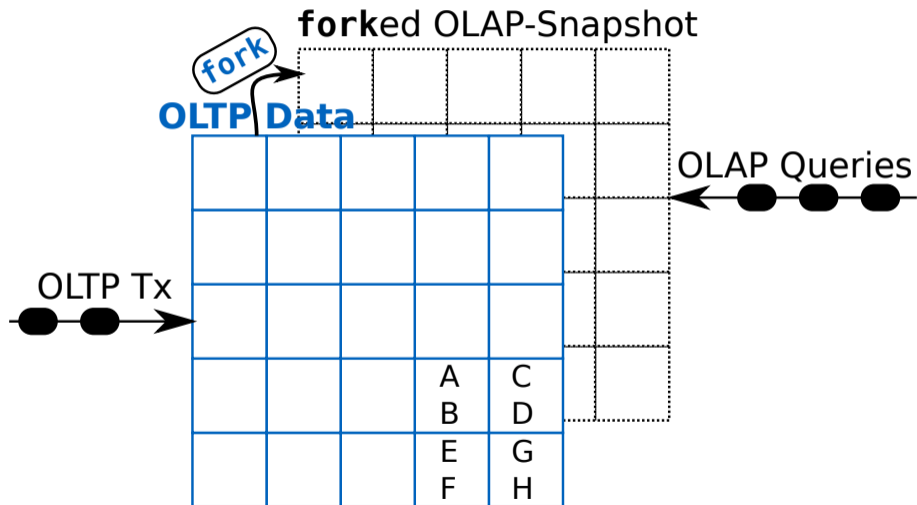

HyPer: Virtual Memory Snapshots

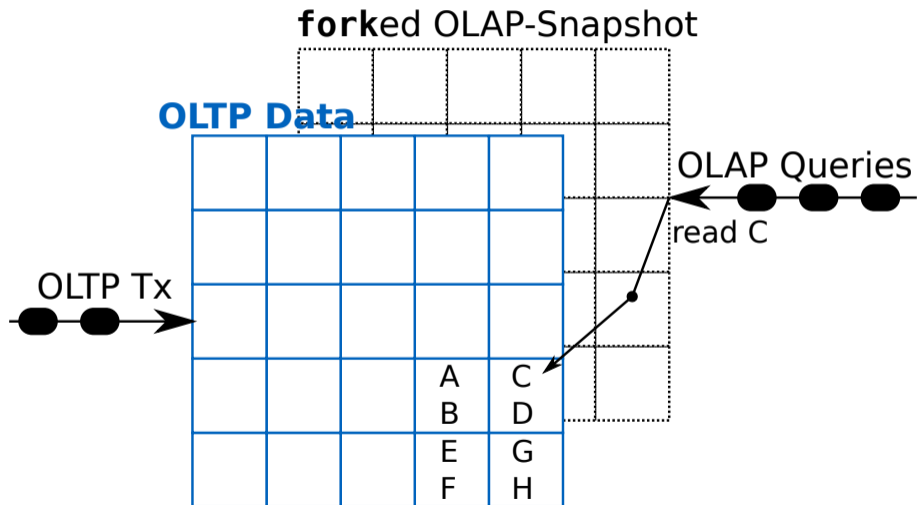

HyPer: Virtual Memory Snapshots

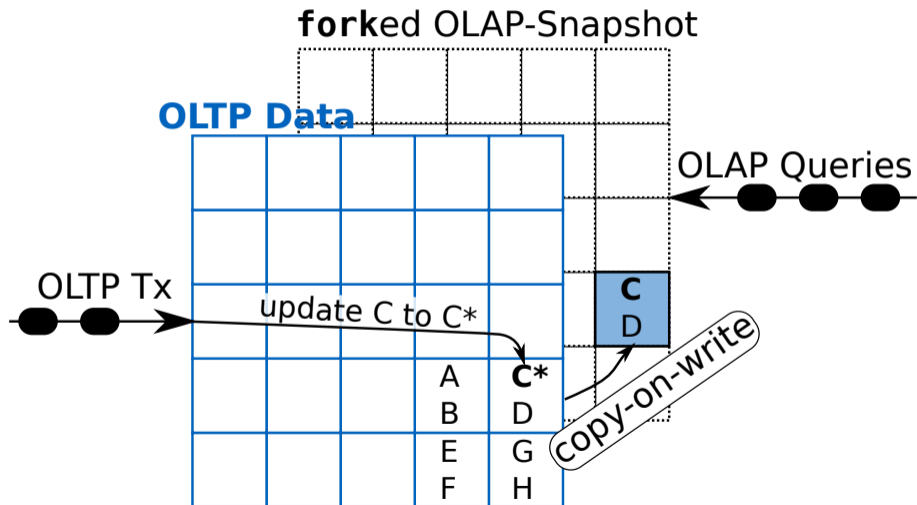

In-Memory Index Structures

- In-memory hash indexes
 - ▶ Simple and fast
 - ▶ Growing is very expensive
 - ▶ Do not support range queries
- Search Trees
 - ▶ BSTs are cache unfriendly
 - ▶ B-Trees better (even though designed for disk)
- Radix-Trees (“Tries”)
 - ▶ Support range queries
 - ▶ Height is independent from number of entries

Radix Trees

Properties:

- Height depends on key length, not number of entries
- No rebalancing
- All insertion orders yield same tree
- Keys are stored in the tree implicitly

Search:

- Node is array of size 2^s
- s bits (often 8) are used as an index into the array
- s is a trade-off between lookup-performance and memory consumption

Radix Tree

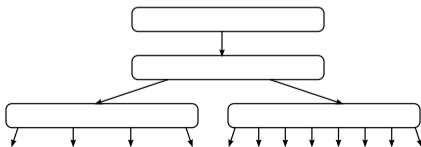

Adaptive Radix Tree

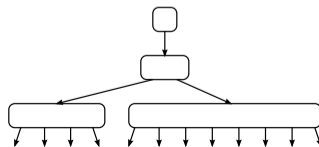

Adaptive Radix Trees

Four node types:

- Node4: 4 keys and 4 pointers at corresponding positions:

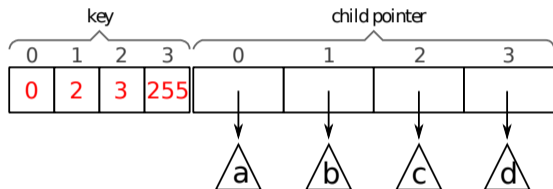

- Node16: Like Node4, but with 16 keys. SIMD searchable.
- Node48: Full 256 keys (index offset), point to up to 48 values:

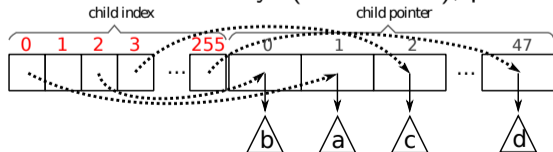

- Node256: Regular trie node, i.e. array of size 256

Additionally: Header with node type, number of entries

Exploiting HTM for OLTP

- Intel's Haswell introduced HTM (via cache coherency protocol)
- Allows to group instructions to transactions
- Can help to implement DB transactions, but
 - ▶ Do not guarantee ACID by themselves
 - ▶ Limited in size/time

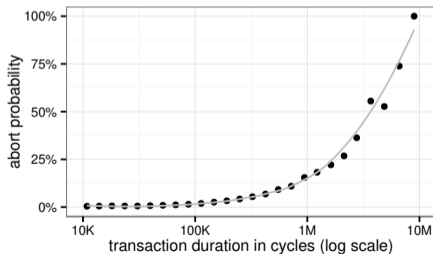
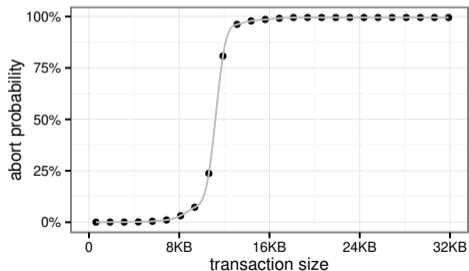

⇒ Use HTM transactions as building blocks for DB transactions

Exploiting HTM for OLTP (2)

Goals:

- As fine-grained as 2PL, but faster
- As fast as serial execution, but more flexible

```
atomic-elide-lock (lock) {  
  account[from]-=amount;  
  account[to]+=amount;  
}
```

Implementing DB transactions with HTM

Use TSO + HTM for latching:

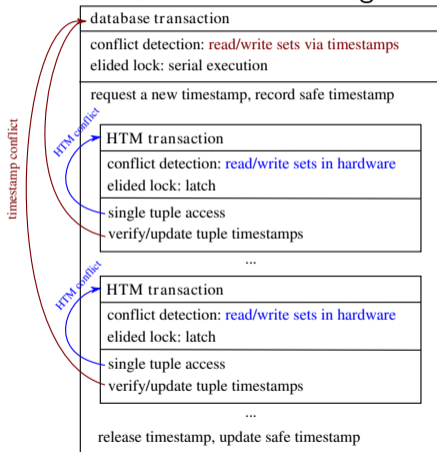

- Relation and index structure layout must avoid conflicts

NUMA-Aware Data Processing

NUMA architectures:

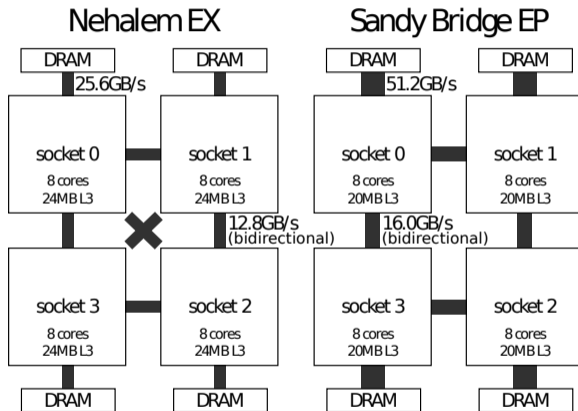

- Local access cheap
- Remote access expensive

NUMA-Aware Data Processing: Hash Join

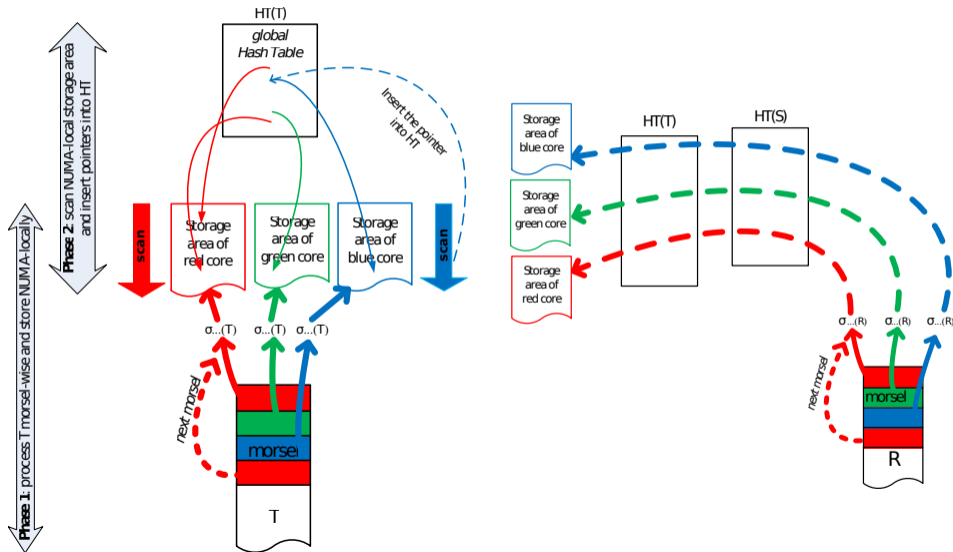

Compaction

- OLTP & OLAP share the same physical data model
 - ▶ Fast modifications vs scan performance
 - ▶ Row store vs column store
- Modifications require snapshot maintenance
 - ▶ Use more memory
 - ▶ Congest memory bus
 - ▶ Stall transactions

Compaction: Hot/Cold Clustering

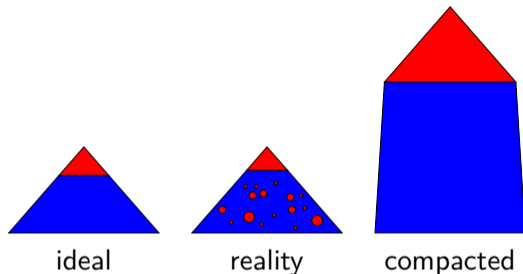

- Compression is applied asynchronously to cold part:
 - ▶ Dictionary encoding
 - ▶ Run-length encoding
 - ▶ Other schemes possible
- Compact snapshots through a mix of regular and huge pages
 - ▶ Keeps page table small
 - ▶ Clustered updates
 - ▶ No huge pages need to be replicated

Compaction: Hot/Cold Clustering

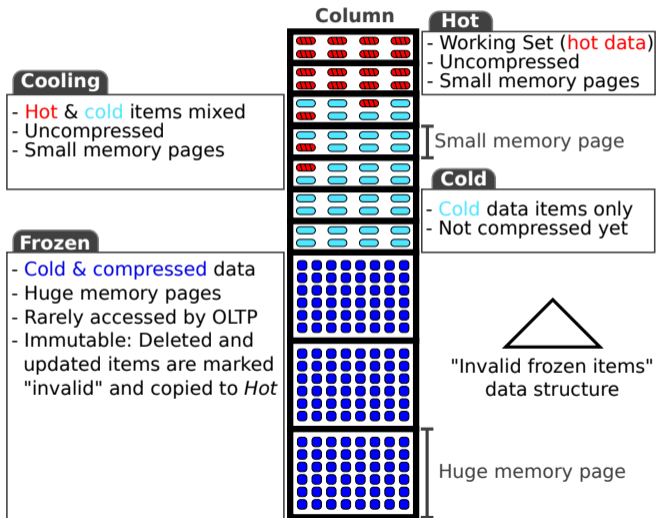

Compaction: Hot/Cold Clustering

How to detect temperature without causing overhead?

1. Software: LRU lists, counters
2. Hardware: mprotect
3. Hardware: dirty and young flags

